

5V 1A 1.5MHz Synchronous Buck Converter

GENERAL DESCRIPTION

The UCT5407 is a high-efficiency, DC-to-DC step-down switching regulators, capable of delivering up to 1.2A of output current. The UCT5407 operates from an input voltage range of 2.5V to 5.5V and provides an output voltage from 0.6V to $V_{IN}-0.3V$, making the device ideal for low voltage power conversions. Running at a fixed frequency of 1.5MHz allows the use of small external components, such as ceramic input and output caps, as well as small inductors, while still providing low output ripples. This low noise output along with its excellent efficiency achieved by the internal synchronous rectifier, making UCT5407 an ideal green replacement for large power consuming linear regulators.

Internal soft-start control circuitry reduces inrush current. Short-circuit and thermal-overload protection improves design reliability.

The UCT5407 is available in SOT23-5 Package.

FEATURE

- High Efficiency: Up to 97%
- Capable of Delivering up to 1.2A
- 1.5MHz Switching Frequency
- No External Schottky Diode Needed
- Low dropout 100% Duty operation
- Internal Compensation and Soft-Start
- 0.6V Reference for Low Output voltages
- Logic Control Shutdown ($I_Q < 1\mu A$)
- Thermal shutdown and UVLO
- Available in SOT23-5

APPLICATIONS

- Cellular phones
- Digital Cameras
- MP3 and MP4 players
- Set top boxes
- Wireless and DSL Modems
- USB supplied Devices in Notebooks
- Portable Devices

TYPICAL APPLICATION CIRCUIT

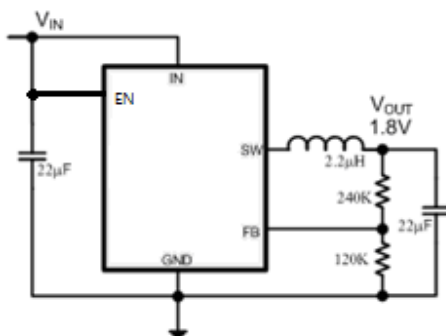

PIN ASSIGNMENT

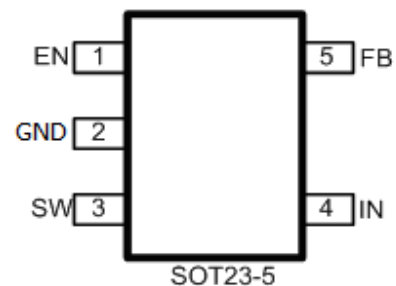

PIN DESCRIPTION

PIN No	SYMBOL	DESCRIPTION
1	EN	Enable pin for the IC
2	GND	Ground
3	SW	Inductor connection.
4	IN	Supply voltage.
5	FB	Feedback input.

ABSOLUTE MAXIMUM RATINGS (Note 1)

Parameter		Value
Max Input Voltage		6.5V
Max Operating Junction Temperature(T _j)		125°C
Ambient Temperature(T _a)		-40°C – 85°C
Maximum Power Dissipation	SOT23-5	400mW
Storage Temperature(T _s)		-40°C - 150°C
Lead Temperature & Time		260°C, 10S

Note1: Absolute Maximum Ratings are threshold limit values that must not be exceeded even for an instant under any condition. Moreover, such values for any two items must not be reached simultaneously. Operation above these absolute maximum ratings may cause degradation or permanent damage to the device. These are stress ratings only and do not necessarily imply functional operation below these limits.

RECOMMENDED OPERATING RANGE

SYMBOL	ITEMS	VALUE	UNIT
VIN	VIN Supply Voltage	2.5 to 5.5	V
TOPT	Operating Temperature	-40 to +85	°C

ELECTRICAL CHARACTERISTICS

$V_{IN}=5V$, $T_A=25^{\circ}C$, unless otherwise specified.

Symbol	Parameter	Conditions	Min	Typ	Max	Unit
V_{IN}	Input Voltage Range		2.5		5.5	V
V_{FB}	Feedback Voltage		0.585	0.6	0.615	V
I_{FB}	Feedback Leakage current			0.1	0.4	μA
I_Q	Quiescent Current	Active, $V_{FB}=0.65V$		70		μA
I_{SD}	Shutdown Current				1	μA
F_{SW}	Switching Frequency			1.5		MHz
R_{ONP}	PMOSFET R_{DSON}			300	450	$m\Omega$
R_{ONN}	NMOSFET R_{DSON}			150	250	$m\Omega$
I_{LIMIT}	Peak Current Limit		1.2			A
I_{SW}	SW Leakage Current	$V_{IN}=5.5V$, $V_{SW}=0$ or $5.5V$, $V_{EN}=0V$			10	μA
I_{EN}	EN Leakage Current				1	μA
V_{ENH}	EN Input High Voltage		1.5			V
V_{ENL}	EN Input Low Voltage				0.4	V
T_{SD}	Thermal Shutdown			150		$^{\circ}C$
HYS_{TSD}	Thermal Shutdown Hysteresis			20		$^{\circ}C$

SIMPLIFIED BLOCK DIAGRAM

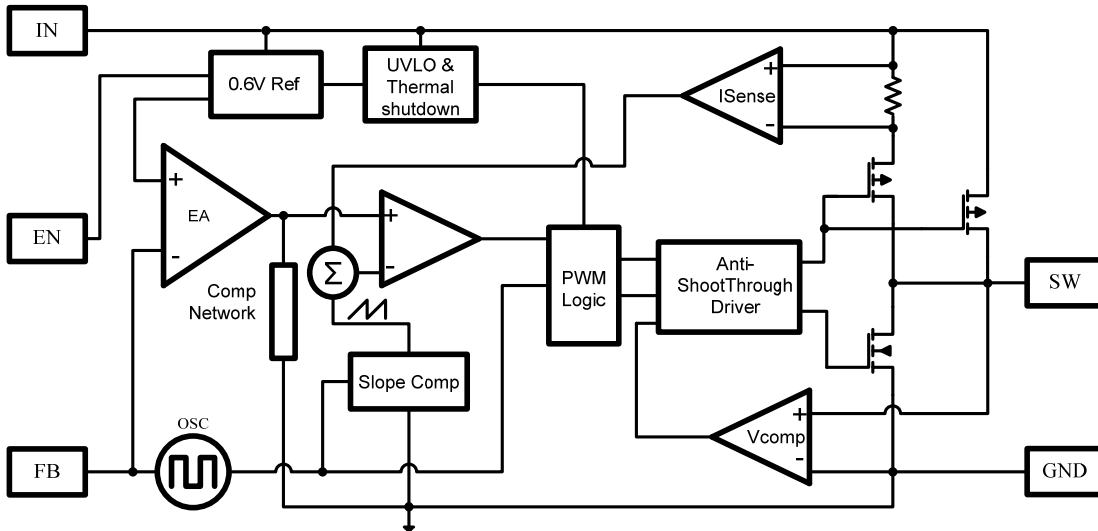

DETAIL DESCRIPTION

The UCT5407 high-efficiency switching regulator is a small, simple, DC-to-DC step-down converter capable of delivering up to 1.0A of output current. The device operates in pulse-width modulation (PWM) at 1.5MHz from a 2.5V to 5.5V input voltage and provides an output voltage from 0.6V to V_{IN} , making the UCT5407 ideal for on-board post-regulation applications. An internal synchronous rectifier improves efficiency and eliminates the typical Schottky free-wheeling diode. Using the on resistance of the internal high-side MOSFET to sense switching currents eliminates current-sense resistors, further improving efficiency and cost.

Loop Operation

UCT5407 uses a PWM current-mode control scheme. An open-loop comparator compares the integrated voltage-feedback signal against the sum of the amplified current-sense signal and the slope compensation ramp. At each rising edge of the internal clock, the internal high-side MOSFET turns on until the PWM comparator terminates the on cycle. During this on-time, current ramps up through the inductor, sourcing current to the output and storing energy in the inductor. The current mode feedback system regulates the peak inductor current as a function of the output voltage error signal. During the off cycle, the internal high-side P-channel MOSFET turns off, and the internal low-side N-channel MOSFET turns on. The inductor releases the stored energy as its current ramps down while still providing current to the output.

Current Sense

An internal current-sense amplifier senses the current through the high-side MOSFET during on time and produces a proportional current signal, which is used to sum with the slope compensation signal. The summed signal then is compared with the error amplifier output by the PWM comparator to terminate the on cycle.

TYPICAL OPERATING CHARACTERISTICS

Tested under $T_A=25^\circ\text{C}$, unless otherwise specified

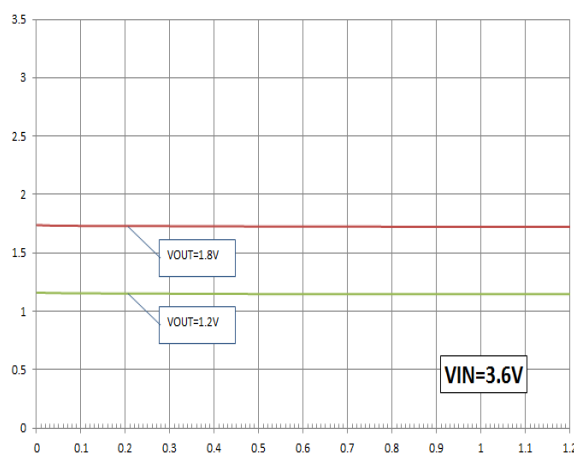
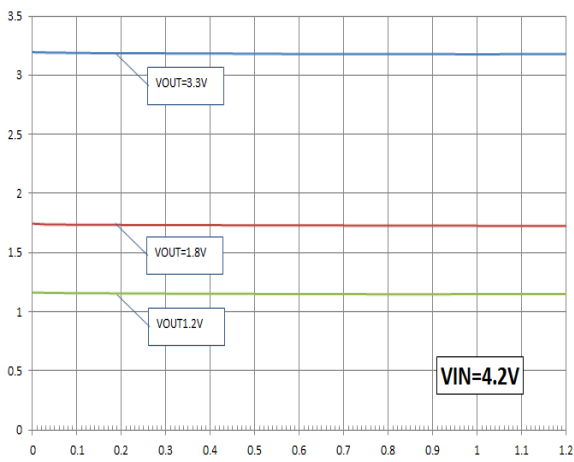
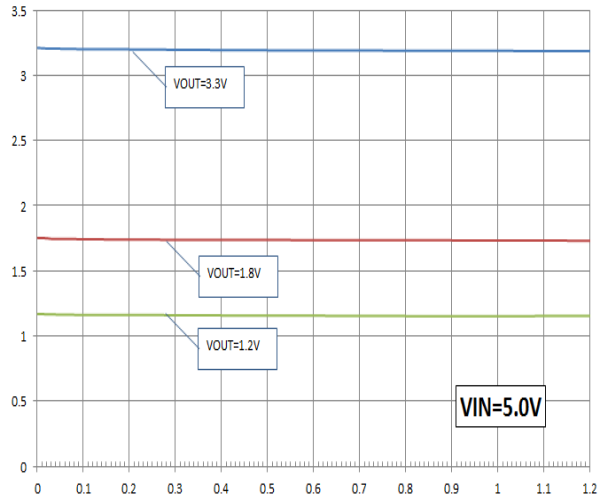
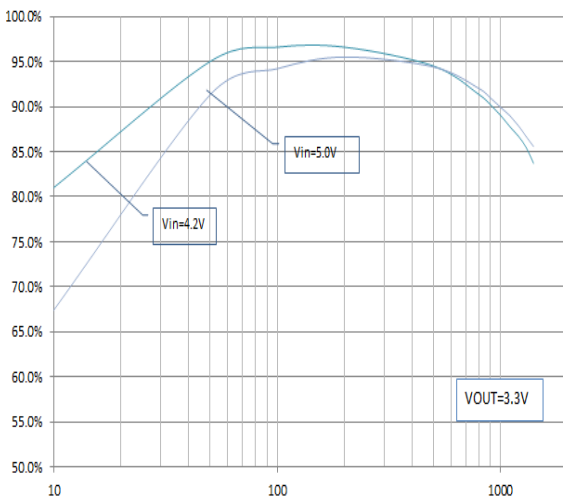
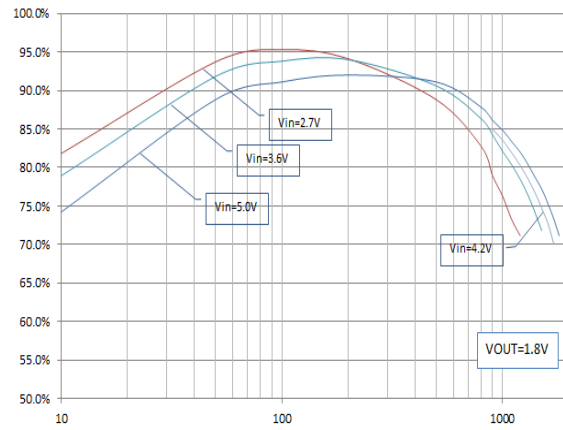
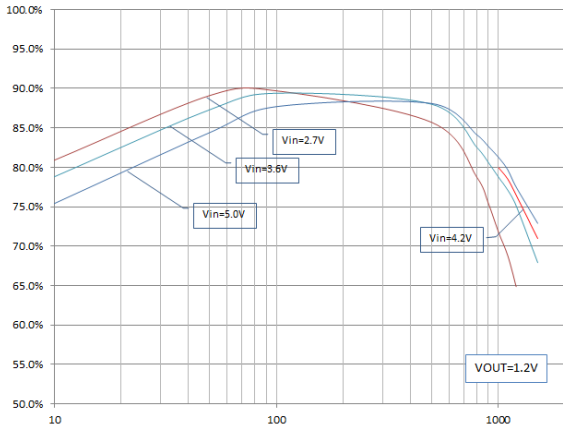

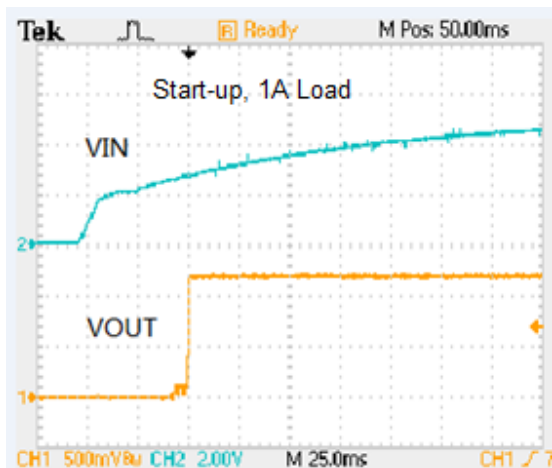
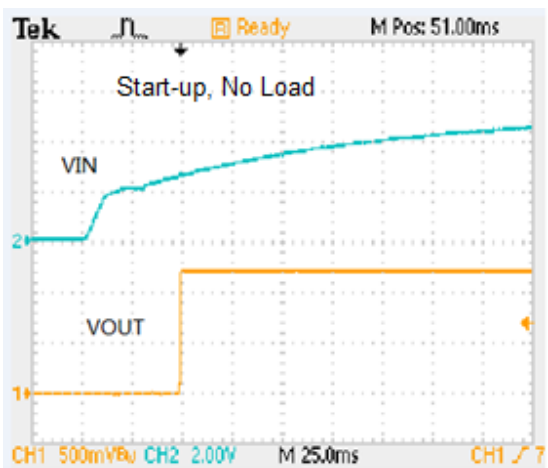
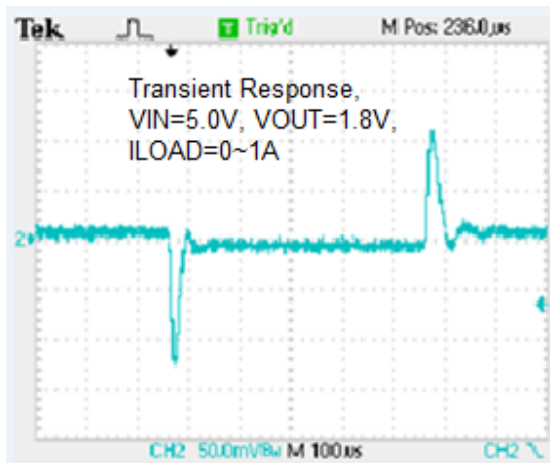
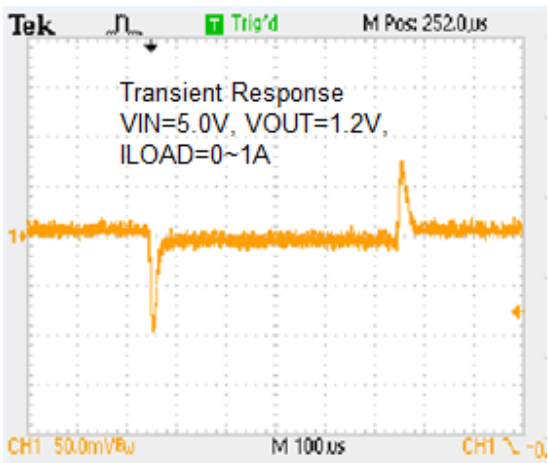
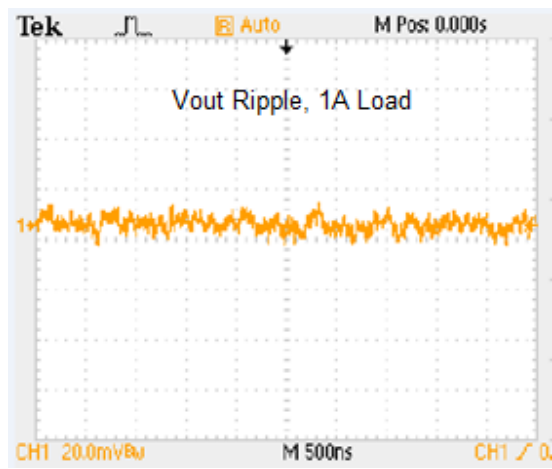
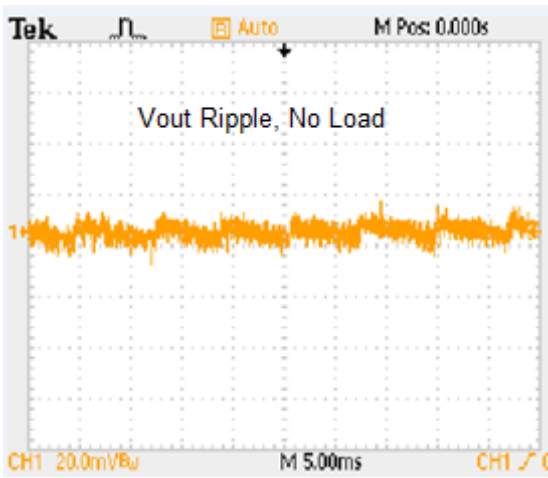

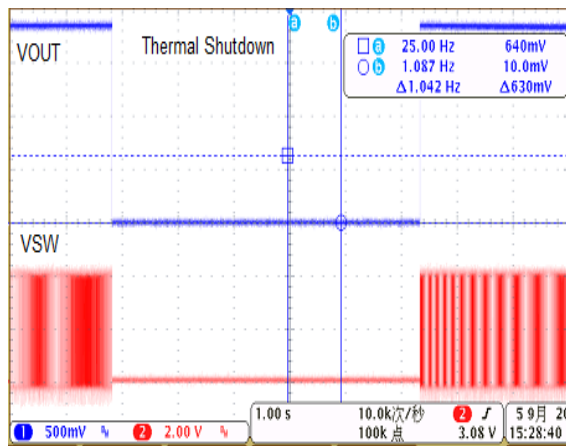
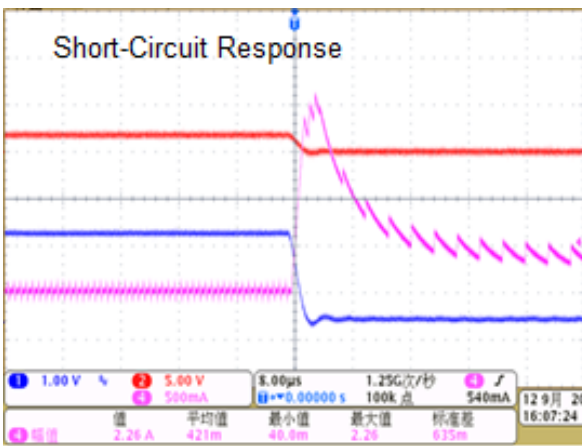
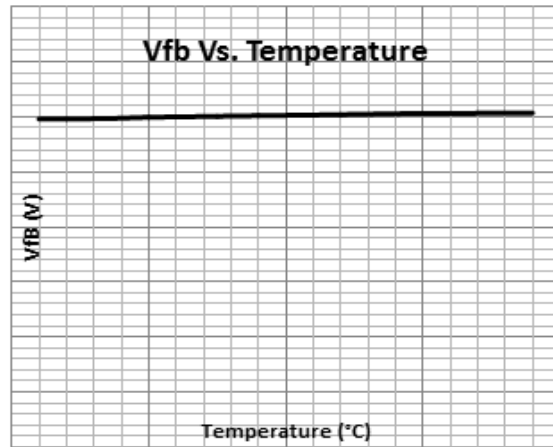
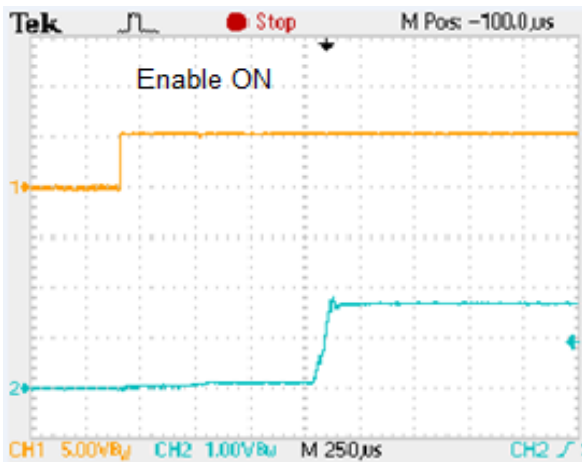

APPLICATION INFORMATION

- **Setting Output Voltages**

Output voltages are set by external resistors. The FB threshold voltage (V_{FB}) is 0.6V.

$$R_{UP} = R_{LOW} [(V_{OUT} / 0.6) - 1]$$

Set R_{LOW} to 100K, then R_{UP} can be easily derived from the above equation.

- **Output Capacitor and Inductor Selection**

Follow the below table for Inductor and Output cap selection:

V_{OUT}	1.2V	1.5V	1.8V	2.5V	3.3V
C_{OUT}	33 μ F	33 μ F	22 μ F	22 μ F	10 μ F
L	1.5 μ H	1.5 μ H	2.2 μ H	3.3 μ H	4.7 μ H

If much smaller values are used, inductor current rises, and a larger output capacitance may be required to suppress output ripple. Larger values than LIDEAL can be used to obtain higher output current, but typically with larger inductor size.

- **Input Capacitor Selection**

The input capacitor in a DC-to-DC converter reduces current peaks drawn from the battery or other input power source and reduces switching noise in the controller. The impedance of the input capacitor at the switching frequency should be less than that of the input source so high-frequency switching currents do not pass through the input source. The output capacitor keeps output ripple small and ensures control-loop stability. The output capacitor must also have low impedance at the switching frequency. Ceramic, polymer, and tantalum capacitors are suitable, with ceramic exhibiting the lowest ESR and high-frequency impedance. Output ripple with a ceramic output capacitor is approximately as follows:

$$V_{\text{RIPPLE}} = I_{\text{L(PEAK)}} [1 / (2\pi \times f_{\text{SW}} \times C_{\text{OUT}})]$$

If the capacitor has significant ESR, the output ripple component due to capacitor ESR is as follows:

$$V_{\text{RIPPLE(ESR)}} = I_{\text{L(PEAK)}} \times \text{ESR}$$

- **Current Limit**

There is a cycle-by-cycle current limit on the high-side MOSFET of 1.2A. When the current flowing out of SW exceeds this limit, the high-side MOSFET turns off and the synchronous rectifier turns on. The UCT5407 utilizes a frequency fold-back mode to prevent overheating during short-circuit output conditions. The device enters frequency fold-back mode when the FB voltage drops below 200mV, limiting the current to 1.2A and reducing power dissipation. Normal operation resumes upon removal of the short-circuit condition.

- **Soft-start**

The UCT5407 has internal soft-start circuitry to reduce supply inrush current during startup conditions. When the device exits under-voltage lockout (UVLO), shutdown mode, or restarts following a thermal-overload event, the soft-start circuitry slowly ramps up current available at SW.

- **UVLO and Thermal Shutdown**

If IN drops below 2.5V, the UVLO circuit inhibits switching. Once IN rises above 2.5V, the UVLO clears, and the soft-start sequence activates. Thermal-overload protection limits total power dissipation in the device. When the junction temperature exceeds $T_J = +160^\circ\text{C}$, a thermal sensor forces the device into shutdown, allowing the die to cool. The thermal sensor turns the device on again after the junction temperature cools by 15°C , resulting in a pulsed output during continuous overload conditions. Following a thermal-shutdown condition, the soft-start sequence begins.

- **Layout Consideration**

Layout is critical to achieve clean and stable operation. The switching power stage requires particular attention. Follow these guidelines for good PC board layout:

- 1) Place decoupling capacitors as close to the IC as possible
- 2) Connect input and output capacitors to the same power ground node with a star ground configuration then to IC ground.
- 3) Keep the high-current paths as short and wide as possible. Keep the path of switching current (C1 to IN and C1 to GND) short. Avoid vias in the switching paths.
- 4) If possible, connect IN, SW, and GND separately to a large copper area to help cool the IC to further improve efficiency and long-term reliability.
- 5) Ensure all feedback connections are short and direct. Place the feedback resistors as close to the IC as possible.
- 6) Route high-speed switching nodes away from sensitive analog area.

PACKAGE OUTLINE

SOT23-5

